



1645 Lexington Avenue ♦ DeLand FL 32724-2106 USA ♦ [www.relativeworkshop.com](http://www.relativeworkshop.com)  
Telephone +1 386 736 7589 ♦ Fax +1 386 734 7537 ♦ [rws@relativeworkshop.com](mailto:rws@relativeworkshop.com)



# Sigma Tandem System

By Relative Workshop

December 2000  
Revision 2

# THE SIGMA TANDEM SYSTEM

<b>Main Deployment System</b>	<b>3</b>
Introduction	3
The Disk Release System (Patent Pending)	4
The Recoil Ripcord System (Patent Pending)	4
The Safety Pin (Patent Pending)	5
How the System Works	5
<b>Other Sigma Tandem System Features</b>	<b>6</b>
A New Drogue (Patent Pending)	6
A New Main Deployment Bag	6
A New Collins' Lanyard (Patented)	6
New Thicker Padding	6
A New Student Harness	7
Exterior Viewing Windows For The Reserve Pin And Cypres	7
Systems Borrowed From The Vector III Solo Rig	7
Summarizing the Advantages of the Sigma Tandem	8
<b>Understanding the Sigma Tandem Drogue</b>	<b>10</b>
Drogue Definitions	10
The Sigma Drogue Collapse Sequence	11
How to check if your drogue kill line is the correct length	12
<b>Understanding the Main Recoil Ripcord System</b>	<b>14</b>
<b>Understanding the Sigma Tandem RSL Collins' Lanyard</b>	<b>15</b>
Assembly	16
Function & Uses	18
Skyhook RSL - Packing Instructions	19
<b>Closing the Main Container – Sigma Tandem</b>	<b>24</b>
Inspect the main closing loop	24
Inspect and pack the canopy	26
Close the main container	27
<b>Sigma Tandem “Pin Check”</b>	<b>43</b>
<b>Installing A New Sigma Drogue Kill line</b>	<b>44</b>
<b>Replacing the Drogue Ripcord System</b>	<b>46</b>
<b>Test For Sigma Tandem Endorsement</b>	<b>47</b>

## THE SIGMA TANDEM SYSTEM

# Main Deployment System

### Introduction

The Sigma Tandem System represents a giant leap forward in safety, comfort, and convenience. Unlike other tandem systems, where the drogue was simply “added on” to existing container system designs, the Sigma Tandem System was designed “from the ground up” as a drogue deployed tandem rig. It utilizes a drogue attachment system that is integral with the main container closing system. That is to say, they are one in the same. When you close the main container, you also attach the drogue. There is no 3-ring to hook up and no pouch to close. When the main container opens, the drogue is released. One cannot happen without the other. Once the main container is closed, the drogue is then stowed exactly like a bottom-of-container hand deployed pilot chute. Except, on this system, snagging the main bridle will not cause an accidental container opening.

On all other tandem container systems, the main container closing and the drogue attachment are two separate systems, at two different locations. While not unreasonably dangerous, such container systems have inherent problems. They are complex and time consuming to pack, and this complexity sets up the possibility of multiple packing errors. But by far the most important problem is, that these systems allow the possibility of the main container accidentally opening, while the drogue is still attached. Since 1989, this scenario has killed 9 tandem pairs. It is the leading single cause of tandem fatalities, accounting for almost one third of the total. By combining the container closing and drogue attachment systems, the new Tandem Sigma eliminates this deadly malfunction.

And because the drogue is attached at the center of the main container, instead of either above or below it, as on other tandem systems, the tandem pair’s body position during drogue fall is not too head high or head low, but much closer to the normal face-to-earth freefall position of a solo jumper. This makes the Sigma Tandem System a more realistic training aid for future skydivers.

# THE SIGMA TANDEM SYSTEM

## **The Disk Release System (Patent Pending)**

At the heart of this system is a specially designed 5-inch diameter disk with a 1-inch flanged “chimney” at its center, through which the drogue bridle passes. This disk is connected to the bridle, about 3 feet from the deployment bag, with a locking pin, which passes through the chimney and a loop on the bridle.

To close the main container, and anchor the drogue, you simply place the main bag in the container, and the disk on top of the bag. You then pass the closing loop, which starts on the bottom flap, through custom D-rings on the other three flaps, and then through a grommet back on the bottom flap, in a circular fashion, drawing the flaps snugly around the disk chimney, thus capturing the disk under the four container flaps. The flanged chimney keeps the disk in place and allows the drogue bridle to exit the container. The closing loop is secured with an eyeleted metal pin through which two lengths of 1000 lb. Spectra line are looped and then secured a few inches below the final grommet to form a pulley. The other end of each Spectra ripcord passes through its own metal housing, one to the right, and the other to the left. Each drogue release ripcord is attached to a spherical ripcord handle by a loop-through-loop connection, making ripcord replacement possible in the field, without any tools. The system is fail-safe, in that total failure of one ripcord would not affect the function of the other.

## **The Recoil Ripcord System (Patent Pending)**

A single 13-inch piece of bungee cord passes through both housings and elastically connects the handles to each other. This holds them firmly against the end of each housing, and causes each handle to recoil back into place after being pulled, or accidentally snagged. This means the handles will always be where you expect them to be. There is no more stowing of loose handles after opening, and no more looking for handles at packing time. For further security, each ripcord handle is countersunk, so that it snugly slides  $\frac{3}{8}$  of an inch over the end of its housing. Each ripcord has 3 inches of slack built in, so that it takes a 5-inch pull, on either handle, to release the drogue.

# THE SIGMA TANDEM SYSTEM

## The Safety Pin (Patent Pending)

The system also incorporates a special “safety pin” on the drogue bridle, which locks the main container pin in place until the drogue is deployed. On all other systems, if you snag a drogue release ripcord moving around the aircraft, or on exit, or if you accidentally pull the wrong handle after exit, you end up with a main canopy as soon as you throw your drogue. The unique safety pin prevents this scenario.

## How the System Works

In tandem, the force exerted by the deployed drogue at terminal velocity is roughly equal to half of the suspended weight. This force, transferred through the disk, is shared (divided) equally by the four main container flaps. Because both ends of the container closing loop are attached to the same (bottom) flap, the closing pin end of the loop only receives half of the force exerted on the bottom flap, or one-eighth of the total force exerted by the drogue. So, if the drogue deployed above a 400 pound tandem pair exerts a force of 200 pounds on the disk, then the container closing pin receives one-eighth, or 25 pounds of force. A stainless steel pin, moving through a Spectra loop, over a stainless steel grommet, has a mechanical advantage of about five to one. So a pull of 5 pounds is all that is necessary to move the pin. But, the Spectra ripcords are set up as 2-1 pulleys, so theoretically a force of only  $2\frac{1}{2}$  pounds at the ripcord handle should move the pin. However, tension from the bungee recoil system, plus eyelet and housing friction, add about 7 pounds of resistance back into the equation, yielding a total pull force, at the handle, of about 10 pounds.

# THE SIGMA TANDEM SYSTEM

## Other Sigma Tandem System Features

### A New Drogue (Patent Pending)

While the drogue canopy is essentially unchanged, the bridle and kill line have been redesigned. The 1¾ ” Kevlar outer bridle extends past the disk all the way to the main deployment bag. The kill line is now 1,000 lb. Vectran/Spectra and also terminates at the bag. Because the lower ends of both the bridle and the kill line end at the same place, it is impossible to twist one independently of the other. This means no more time consuming untwisting of the kill line. Because both bridles are now made of non-stretch materials, no “stop ring” is required on the inner bridle. This means less wear, and that the kill line can be easily replaced in the field. And because both the bridle and the kill line share the bag lift-off forces (On all other systems either the kill line or outer bridle takes it all alone) if either the bridle or the kill line breaks, deployment still happens more or less normally, and you don't lose your drogue.

### A New Main Deployment Bag

The Sigma Tandem main deployment bag has also been redesigned, eliminating the grommet at the top of the bag, and replacing it with a continuous loop of tubular nylon. This prevents canopy damage caused by pinching at the bag attachment point. **A New Collins' Lanyard (Patented)** The Sigma Tandem now integrates our proven “Collin's Lanyard” system into the yoke for a totally hidden installation. This system automatically releases the other main riser if the RSL-side main riser breaks, or releases prematurely for any reason. This prevents a potentially fatal main/reserve entanglement. You can only get this important safety system on a Vector.

### New Thicker Padding

Both the Tandem instructor and student harnesses feature our exclusive ½ ” thick “Wonderfoam” padding for a more comfortable ride.

# THE SIGMA TANDEM SYSTEM

## **A New Student Harness**

The New Sigma student harness is designed to be far more comfortable, while at the same time offering more control on exit, and forcing the student's legs forward and upward under canopy. This means fewer students will get sick or pass out under canopy. It also means fewer landing injuries, a greater return and progression rate, and a better review of their tandem jump to friends, which in turn means more, and happier students.

## **Exterior Viewing Windows For The Reserve Pin And Cypres**

Now you can view your reserve locking pin, and turn your Cypres on and off through clear windows, without opening your reserve pin cover flap. The reserve pin window is made of Lexan, and simply slides into place for easy replacement if it becomes badly scratched. The Cypres window is just above the reserve pin cover flap, so a pin check, and Cypres condition check can be accomplished at a glance, even while you are wearing the rig.

## **Systems Borrowed From The Vector III Solo Rig**

Sigma Tandem Systems also share many features with our Vector III solo systems. Riser covers, and both main and reserve pin cover flaps, incorporate tuck-tabs instead of Velcro. The main container side flaps wrap around the bottom of the container to provide positive bridle protection. These systems set the industry standards for superior pin and main bridle protection, as proven by years of field-testing and use.

## THE SIGMA TANDEM SYSTEM

### Summarizing the Advantages of the Sigma Tandem

1. It takes fewer steps, with fewer potential errors, to close the main container.
2. Accidentally snagging the drogue bridle will not open the container.
3. Out-of-sequence deployments are eliminated.
4. Its center-of-main-container drogue connection gives a more “natural” and comfortable drogue-fall position than other Tandem systems.
5. The drogue release ripcords are automatically retracted after use, or accidental snagging, so that they are always where they should be, cannot be lost, and don’t have to be stowed after pulling.
6. It has two redundant, fail-safe drogue release ripcords, one on the right, and one on the left.
7. The drogue release/container opening pin is “locked” until you throw the drogue, preventing accidental high openings.
8. No more time consuming untwisting of drogue kill line during packing. Kill lines can be easily replaced in the field.
9. You still get a more or less normal deployment if the kill line breaks, and you don’t lose your drogue.
10. It’s improved deployment bag means less canopy damage.
11. It has an improved student harness, which means safer and more comfortable students, and their positive word-of-mouth advertising will increase your tandem business.
12. The “Collin’s Lanyard,” and all its advantages, is available only on a Vector.
13. It has tuck-tab main, reserve, and riser covers.
14. Clear plastic windows make reserve pin checks and Cypres operation easier.
15. It has “Wonderfoam” padding throughout.

**The Sigma is made to the highest quality standards in the industry by the Relative Workshop.**



# THE SIGMA TANDEM SYSTEM

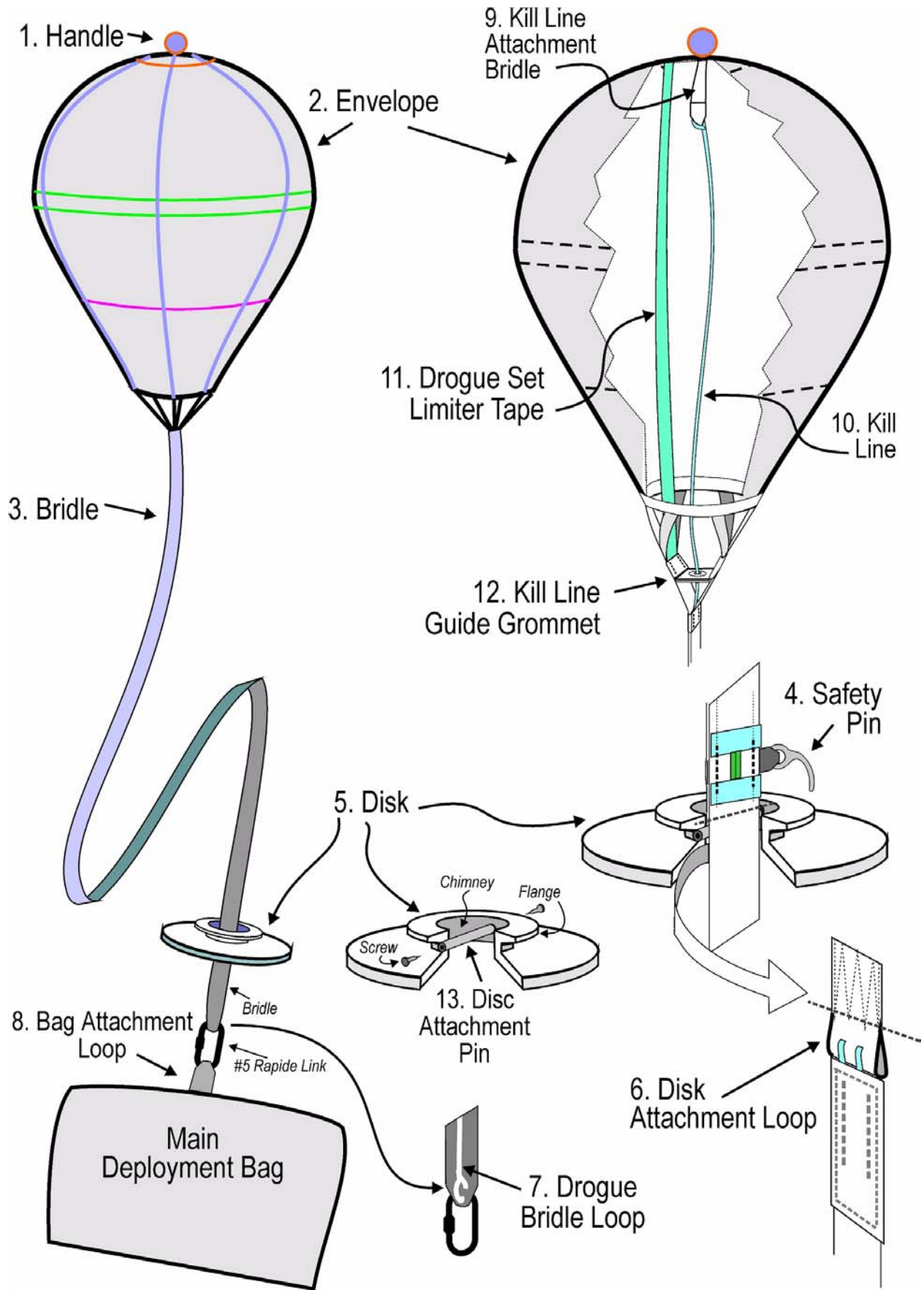

# THE SIGMA TANDEM SYSTEM

## Understanding the Sigma Tandem Drogue

### Drogue Definitions

#### Exterior – Top Down

1. **Handle** – The 1-5/8in ball, connected to the apex of the drogue envelope, used to deploy the drogue.
2. **Envelope** – The fabric and mesh portion of the drogue. Its top is called the apex, its bottom the base.
3. **Bridle** – The doubled, 1¾", 4,000 lb. Kevlar section that leads from the envelope to the deployment bag connection loop.
4. **Safety Pin** – A compound-curved pin connected to the bridle, designed to prevent accidental main container openings.
5. **Disk** – A 5" aluminum disk, with a 1" flanged chimney.
6. **Disk Attachment Loop** - A loop on the Kevlar drogue bridle to which the disk is attached with a stainless steel pin, held in place with two flat head screws. A 3/32" hex drive is required to tighten or loosen screws.
7. **Drogue Bridle Loop** – The loop at the end of the Kevlar drogue bridle, to which the deployment bag is attached.
8. **Bag Attachment Loop** – A loop of tubular Nylon at the top of the main deployment bag where both the bridle and kill line are attached by means of a #5 stainless rapid link.

# THE SIGMA TANDEM SYSTEM

## Interior – Top Down

**Kill Line Attachment Bridle** – A 9” length of 1” Nylon tape that serves as an attachment point for the kill line, and limits the degree of collapse if a kill line is accidentally made too short.

**Kill Line** – A length of 1,000 lb. Vectran/Spectra line, with a 1” loop at each end, that runs inside the Kevlar drogue bridle from the kill line attachment bridle to the rapid link at the bag attachment loop.

**Drogue Set Limiter Tapes** – Two pieces of 1” Nylon tape that run from the drogue apex to the drogue skirt. This saves wear and tear on the drogue bridle and kill line by limiting the distance they slide on each other during drogue collapse.

**Kill Line Guide Grommet** – A “0” stainless steel grommet at the base of the drogue envelope which directs the kill line into the Kevlar drogue bridle preventing wear. It also serves as an emergency stop for the kill line attachment bridle if the kill line is accidentally made too short.

**Disk Attachment Pin** – A threaded stainless steel rod, used to attach the disk to the bridle, using 2, 3/32” hex drive screws.

## The Sigma Drogue Collapse Sequence

The collapse sequence on the Sigma drogue is the same as on previous Vector drogues. The drogue partially collapses, at a controlled rate during bag lift-off, yielding just the right amount of force for an orderly deployment. However, the method of collapse is slightly different.

The drogue bridle and kill line now both end at the same place, a rapid link connected to the top of the deployment bag. When the drogue is set (or cocked) during the packing sequence, the Kevlar drogue bridle below the disk is “scrunched up”, effectively making the bridle shorter than the kill line. When the drogue is deployed, it can inflate because the kill line is longer than the bridle. When a ripcord is pulled to end droguefall, the container opens and the disk is released, allowing the “scrunched up” section of the bridle below the disk to extend to its full length, thus making the bridle longer than the kill line. This inverts the drogue apex, collapsing the drogue.

Because both the drogue bridle and kill line are made of non-stretch materials, the drogue collapse sequence is “stopped” automatically, at just

## THE SIGMA TANDEM SYSTEM

the right point. No ring, slamming into a “stop ring” at high speed is needed, and the bridle moves over the kill line for a much shorter distance than on the previous design. This means less friction is generated, so everything lasts longer. And with no stop ring, the kill line is much less complicated and easier to replace. Also, because both the drogue bridle and kill line end at the same place, it is impossible to twist one independent of the other. This means no more time consuming untwisting of the kill line at pack time.

### **How to check if your drogue kill line is the correct length**

For this system to work correctly, a precise relationship between the length of the drogue bridle and the length of the kill line must be maintained. To check this relationship:

1. Anchor the rapid link at the deployment bag end of the drogue bridle. Both the drogue bridle and kill line should be connected to this link.
2. Extend the drogue bridle fully.
3. Put a finger on either side of the kill line guide grommet at the base of the drogue, and apply about 10 lbs. of tension against the Kevlar bridle.
4. With the other hand apply the same tension on the kill line by pulling on the kill line attachment bridle or the drogue handle. The larks head knot at the bottom of the kill line attachment bridle should be 1½ ” above the kill line guide grommet.

**You can notice this relationship less formally each time you pick up your drogue after landing.**

If this distance is more than 2” greater, the drogue may not fully collapse, yielding a higher snatch force, increased chance of malfunction due to line dump, and increased chance of canopy damage. **If you notice a kill line that is over 2” too long**, a simple overhand knot, tied within the finger-locked section of the kill line, at the deployment bag end, will effectively shorten it almost 2”, and bring your drogue collapse system back into trim.

If this distance is more than 1” less, the larks head knot will impact the guide grommet at high speed, quickly causing damage to both. However, in this instance, deployment, while slightly slower, will still happen more or less normally.

# THE SIGMA TANDEM SYSTEM

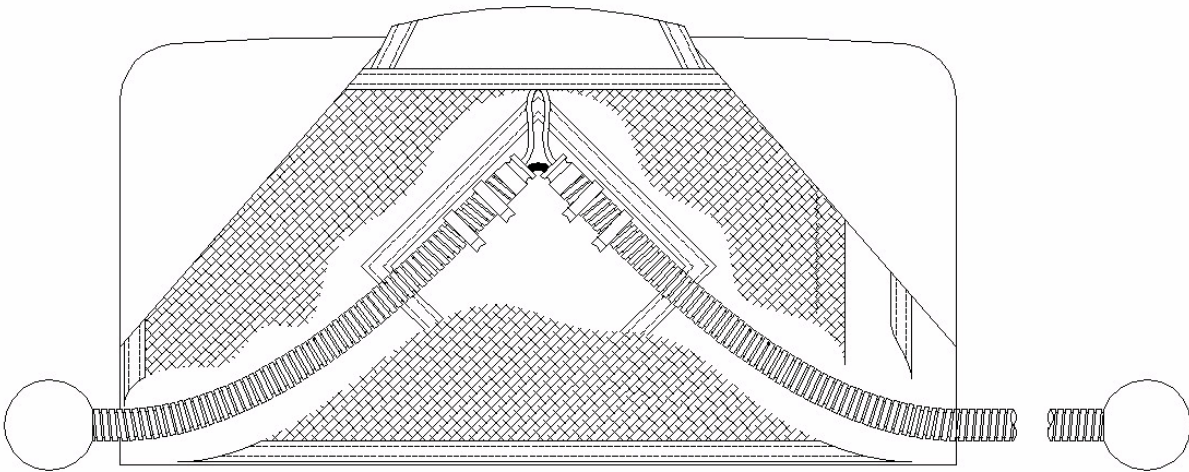

Figure 1  
Release Handle System  
(Broken view of spandex for clarity)

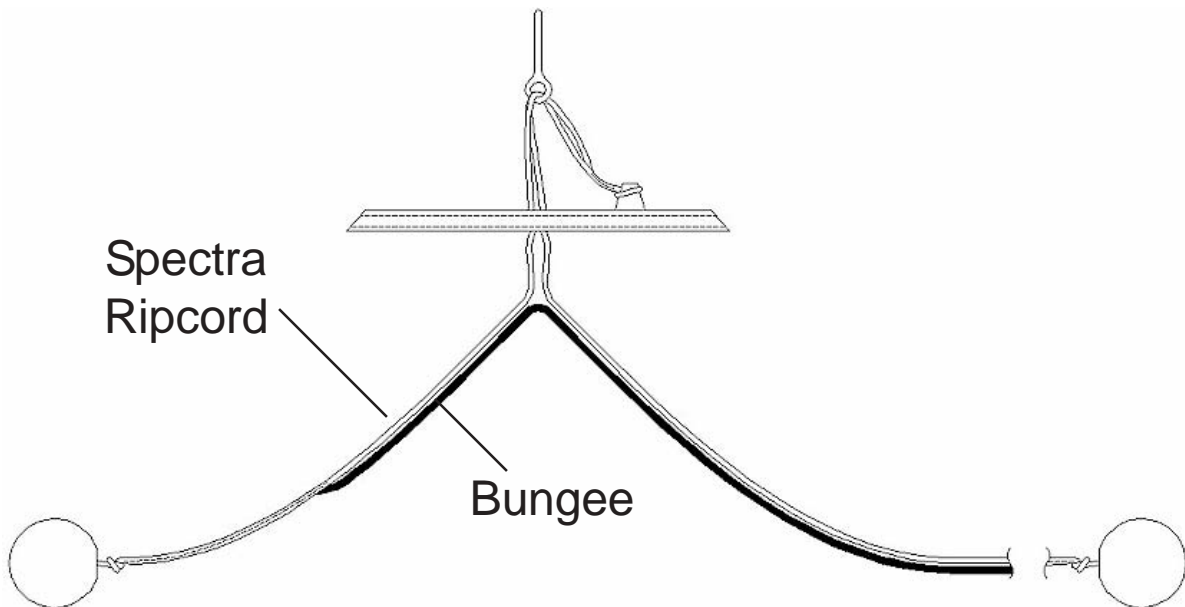

Figure 2  
Ripcord Detail  
(Housings, etc. removed for detail)

## THE SIGMA TANDEM SYSTEM

### **Understanding the Main Recoil Ripcord System**

The Recoil Ripcord System for the Tandem Sigma drogue consists of:

1. A single length of 1,000 lb. Spectra line with finger locked loops at each end, and near the center.
2. A single length of 1/8" bungee cord, finger locked between the loops at each end of the Spectra line.
3. Two, specially prepared, solid core ball handles.
4. One stainless steel, eyeleted, ripcord pin.
5. Two stainless steel ripcord housings.

One ripcord handle is located at the bottom left corner of the main container, and the other on the right leg pad, allowing the tandem instructor to release the drogue with either hand. The right handle is positioned on the tandem instructor's harness so as to simulate a Bottom of Container (BOC) position for the student. You don't have to hook it up to the student harness before each jump. It is automatically in the right position.

There are no "ripcord pockets" per say. Each ripcord handle "plugs into" the end of the housing, and is held in position by a combination of friction, and the pull of the bungee cord retract system.

Pulling either handle about 5" pulls the single ripcord pin, opening the container and releasing the drogue. Notice that each ripcord is set up as a 2-1 pulley, so that a pull of 5 pounds at the handle translates into a pull of 10 lbs at the pin, resulting in easy pulls every time.

Once the drogue is released, as evidenced by the "trap door effect", you can simply let go of the handle. It will automatically return to its position on the end of the ripcord housing. Although the housings are double clamped into position under the drogue pouch for maximum security and long life, excessive pulling on the ripcord handles after drogue release might eventually damage these housing connections. You don't have to baby the system, but pull only as far as necessary to release the drogue, and then let go of the handle.

## THE SIGMA TANDEM SYSTEM

The advantages of this system are obvious. The spherical shape of the ripcord handles, and their method of attachment, makes snagging highly unlikely. If dislodged, they automatically return to position, so no more searching for “floating” ripcords. And the unique “Safety Pin”, connected to the drogue bridle, makes it virtually impossible for a snagged ripcord handle to cause an accidental container opening. And let’s not forget, you no longer have to waste time and effort stowing the handles after opening, or searching for them at packing time.

Because this system is new (The first production rigs went into service Summer 2000), we don’t yet know how long the recoil ripcord system will last under actual field conditions. Although bench tests show that the ripcord system can last for over 1,000 jumps, you should inspect the whole system often for signs of wear.

Look for wear at the junction of the Spectra ripcords and the handles, and around the pin area. The Spectra is 1,000 lbs. strong, and the force required to pull the pin is less than 10 lbs. That’s over a 100 to 1 safety margin, so a small amount of fraying should not be cause for alarm. Besides, the ripcord system is designed to be redundant. If one side were to break or jam for any reason, the other side is still fully functional.

Also notice if the recoil system is doing its job properly. With the rig packed, each ripcord should snap back into place when pulled a few inches and released. But please realize, if you pull and release each ripcord handle several times before each jump, you will shorten the life of the system by a factor of three. Inspect, but don’t play with the system incessantly if you want maximum life from your ripcords.

### **Understanding the Sigma RSL Collins’ Lanyard**

The Collins’ lanyard was designed to prevent a main-reserve entanglement, by releasing the left (non-RSL side) main riser, in the event that the right (RSL side) main riser breaks or prematurely releases by itself, for any reason. On the Sigma, it is integrated into the RSL with no external lanyard. This is accomplished by threading the left riser 3-ring release cable through a loop in the reserve static line (RSL). As the right riser leaves, the RSL automatically pulls the left cutaway cable as it pulls the reserve pin, yielding a clean breakaway and stable reserve deployment.

## THE SIGMA TANDEM SYSTEM

On the Sigma Tandem System, the RSL also serves as an emergency right hand reserve ripcord handle. Because of this double function, a TruLok pin (see Fig. #1) has been installed on the 1", Type 4 section of the RSL bridle, to prevent accidental reserve deployment (and partial cutaway), when all you meant to do was release the RSL in preparation for a high wind landing.

### Assembly

1. Open the Velcro channel on the right shoulder pad, under the riser cover. Insert the Tru-Lok pin downward into its slot, (Figs. #1, 1a), mate the Velcro above it, and close the Velcro channel over it. (Fig. #2) The pin is now locked into place, and should stay put until the next breakaway/reserve activation. It can only be removed by an upward pull.

**Figure 1**



**Figure 1a**



**Figure 2**



## THE SIGMA TANDEM SYSTEM

2. Insert the long (left side) breakaway cable through its first housing, which ends in the yoke section of the rig. Next insert this same cable through the loop in the 1" section of the RSL (Fig. #3), and then into its second housing, which leads to the left main riser. Feed the right breakaway cable through its single housing in the normal manner.



**Figure 3**

3. Hook up your main risers in the normal manner.
4. Connect the RSL snap shackle to the right main riser RSL connector ring. (Fig. #4)



**Figure 4**

## THE SIGMA TANDEM SYSTEM

### Function & Uses

To release the RSL in preparation for a high wind landing, pull down on the yellow release tab only (Fig. #5). With the Tru-Lok pin in place, it is virtually impossible to pull downward hard enough to activate the RSL.

On Sigma's with Skyhooks the right hand reserve ripcord (Crystal Ball) has been removed because of operational conflict. The loop-style left hand reserve handle can be pulled with the right hand if necessary.



**Figure 5**



**Figure 6**

## SKYHOOK RSL - PACKING INSTRUCTIONS

A standard RSL does one thing. It pulls the reserve ripcord pin automatically after a breakaway. The Skyhook RSL does this, and then goes two steps further.

A. It automatically releases the Left (non-RSL) riser, if the right (RSL) riser releases prematurely for any reason (Collins' Lanyard). (You wouldn't want your reserve container opened with one riser still attached, would you?)

B. It then uses your departing main canopy as a super "pilot chute" to get your reserve to line stretch faster than ever before. Breakaway, to canopy-out-of-bag times are between  $\frac{1}{2}$  and  $\frac{3}{4}$  of a second, depending on the size of your reserve canopy. This is up to three times faster than a pilot chute can do it alone.

If you have a main total malfunction, or your AAD fires, the Skyhook Lanyard automatically releases, and therefore does nothing to hinder normal reserve deployment.

The Skyhook RSL System has four parts:

1. The RSL Lanyard (5/8 or 1", black webbing) with a snap shackle that connects to your right main riser at one end, and the Collins' Lanyard loop at the other.
2. The White Ripcord Lanyard, with one end sewn to the RSL loop, and the reserve ripcord pin at the other.
3. The Red Skyhook Lanyard, also sewn to the RSL loop, with the Skyhook attachment loop at its free end.
4. The Skyhook itself, which is sewn to the reserve pilot chute bridle.

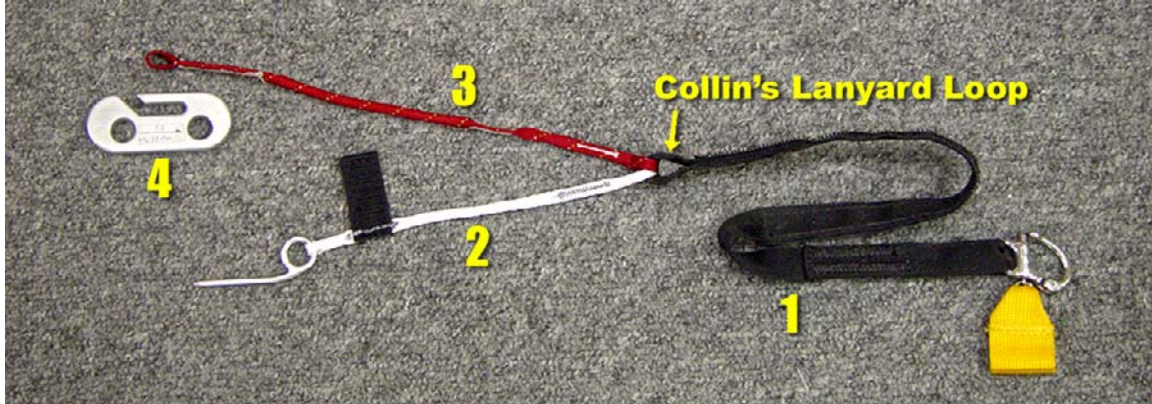

(Because the RSL Lanyard, Collins' Lanyard, and Skyhook Lanyard are all part of one integrated system, pulling the yellow tab on the RSL snap shackle inactivates all three.)

# SKYHOOK RSL - PACKING INSTRUCTIONS

## WARNING - Before Packing:



Note: There is no RSL guide Ring on flap #6 on Skyhook equipped rigs. Make sure the RSL guide ring has been removed on converted rigs. It was never really necessary, and someone might pass the

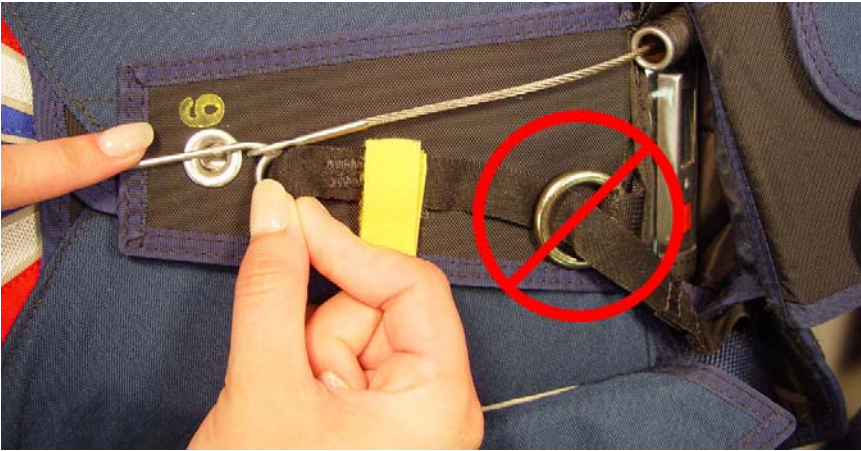

Make sure the left hand (exposed) yellow breakaway cable passes through the Collins' Lanyard loop at the end of the

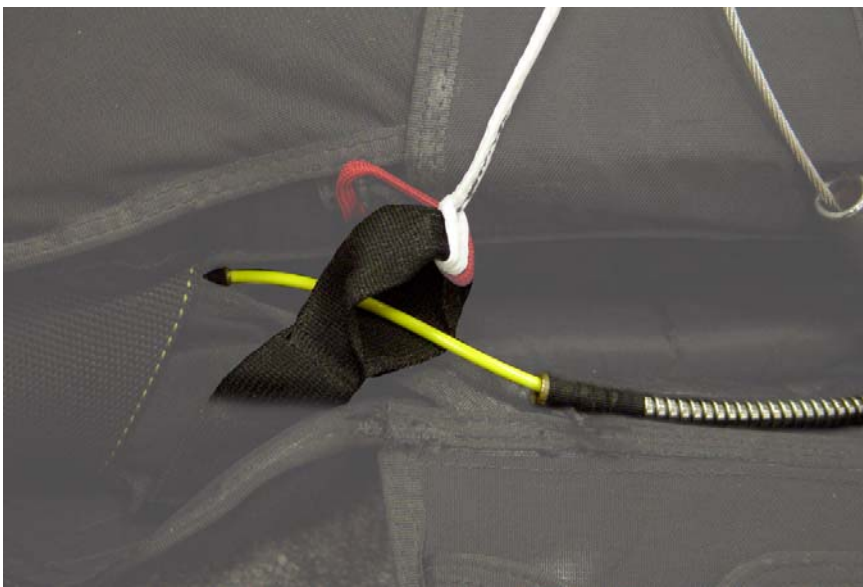

Make sure that the Skyhook is sewn to the reserve freebag bridle correctly, with the pointed end of the hook facing toward the bag. If the Skyhook were sewn on the bridle facing the wrong way, a reserve pilot chute in tow would result if the reserve were pulled in response to a main total. (This pilot chute in tow could be cleared by pulling the yellow tab to release the RSL.) Remember, this malfunction can

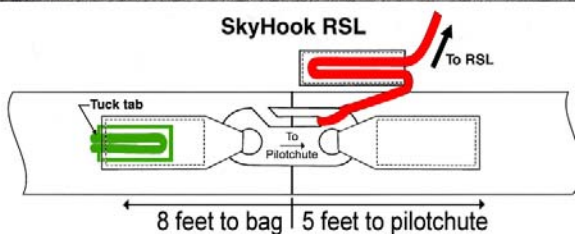
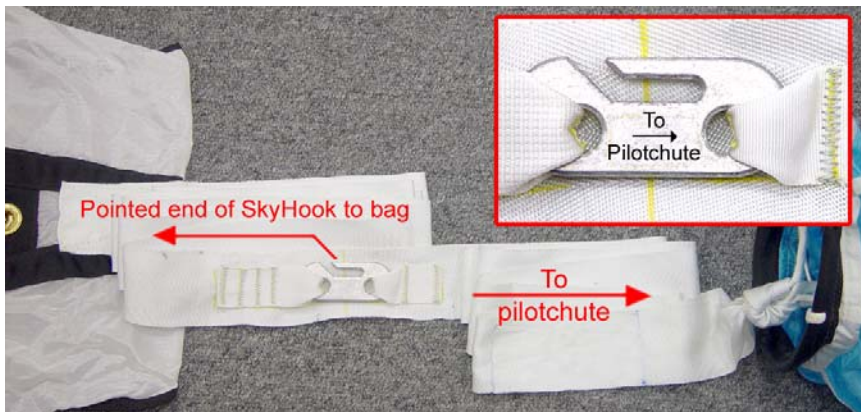

## PACKING

1. Place the bagged reserve canopy in the container as described in the Vector 3 Owner's Manual.



2. S-fold the 8-foot section of freebag bridle (up to the Green flex-tab) under pilot chute kicker flap #1, in the normal manner. Close flap #2, and secure with the reserve closing loop and temporary pin. Make sure the remaining bridle exits the closed kicker flaps to the wearer's LEFT (Right in photos) of the #2 (upper) flap, with the flex-tab side up.



3. Attach the RED Skyhook lanyard to flap #2 by folding the stiffened section of the lanyard in half, and inserting it completely into the RED pocket on the flap. You may have to open the pocket a little with a pencil before inserting the flex-tab.



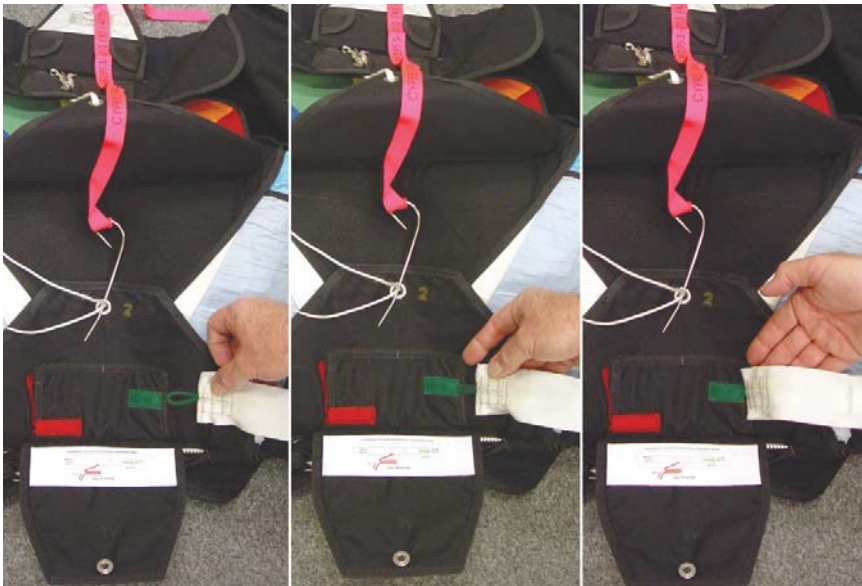

4. Fold the bridle over the edge of flap #2, and insert the GREEN flex-tab on the freebag bridle into the GREEN pocket on the #2 flap.



5. Lay the bridle over flap #2 with the Skyhook facing up. Lift the Lexan cover slightly, rotate the Skyhook enough to slip the loop on the end of the red Skyhook lanyard over the Skyhook, and rotate back into position. The Skyhook should be held firmly in place between the two pockets with less than 1/4" of play. (Note: It should take a force of 5-7 lbs. to pull the red or green flex-tab out of its pouch, at a 180 degree angle to the mouth of the pouch.)



**Hand tack the Red Skyhook Lanyard to the white free bag bridle with a single piece of red rigger seal thread and lock with a surgeon's knot**

## **n**ote

(NOTE) The Skyhook has a Lexan cover piece designed to:

1. Hinder anything but the Skyhook Lanyard from entering the Hook-slot.
2. Lower the chance that the hook area might be damaged by use or misuse. Make sure this cover is in good condition. Make sure the hook area is smooth and

6. Close the Skyhook cover flap (2A) over the Skyhook assemblage, pass the reserve closing loop through its grommet, and secure with the temporary pin.



(WARNING) Make sure that the Skyhook lanyard goes directly from the RSL lanyard to the Skyhook hardware, without going



7. S-fold the remaining 5' of freebag bridle on top of flap 1, and continue packing according to the existing Vector 3 Owner's manual starting at page 28, #6.



**Completed packjob.**

## THE SIGMA TANDEM SYSTEM

### Closing the Main Container – Sigma Tandem

#### Inspect the Drogue Release Recoil Ripcord System (Fig. #1)

1. Make sure the eyeleted stainless steel pin is straight and free of burrs.
2. Pull all slack Spectra ripcord up out of the housings, remove any twists, and check for wear. Each ripcord is independent of the other; over 1,000 lbs. strong, and only sees 10 lbs. in use. So a small amount of wear is nothing to be concerned about.
3. Pull each ripcord handle to check the recoil function, and examine the loop-to-loop connection at each handle for wear.
4. Make sure the ripcord housings are secure.

#### Inspect the main closing loop

The main container-closing loop (**Fig. #2**) is also constructed of

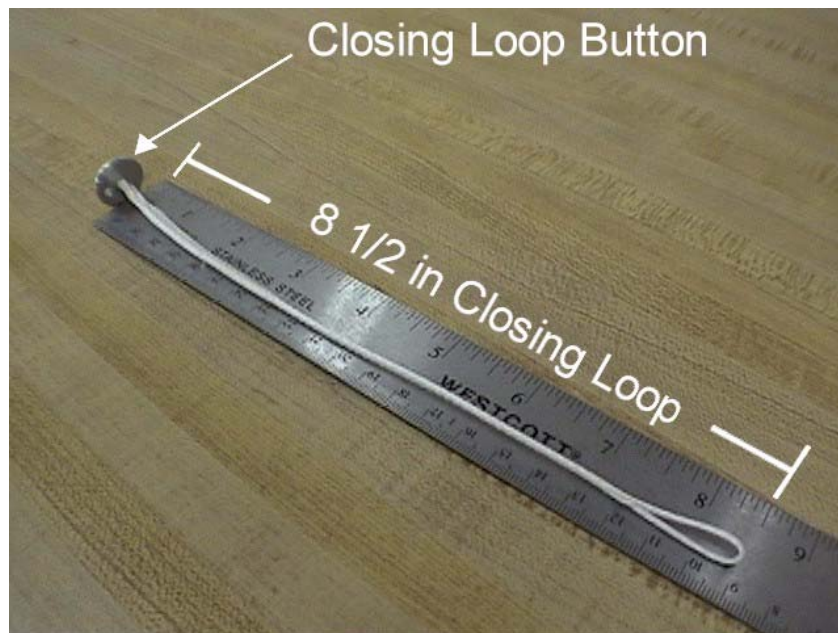

Figure 2



## THE SIGMA TANDEM SYSTEM

1,000 lb. Spectra line, and finished to a set length. Spectra is used because of its low surface friction. **Any other line** (other than Teflon, which is too weak) **would cause a hard or impossible pull in this application.** The “sewn to button” construction technique is used because knots in Spectra slip, and there is only one correct length (**8½ ”**) for the closing loop anyway. However, Spectra has a low melting temperature, so the pull-up cord used to close this rig must also be Spectra. Friction caused by the use of Nylon or Dacron pull-up cords, even when extreme care is taken, will very quickly damage the container closing loop. Replace any loop, which is badly worn. It is not necessary to replace a loop that is just slightly fuzzy. With proper care a loop can last 100 jumps or more. If you insist on using nylon pull up cords, your closing loop must be replaced every few jumps. This can get expensive. **Spare loops and pull-up cords are stored in the main top flap pouches.**

**WARNING:**  
**Do not fabricate your own closing loops.**  
**Do not use anything but Spectra as a pull-up cord.**

### Inspect the drogue. (Fig. #3)

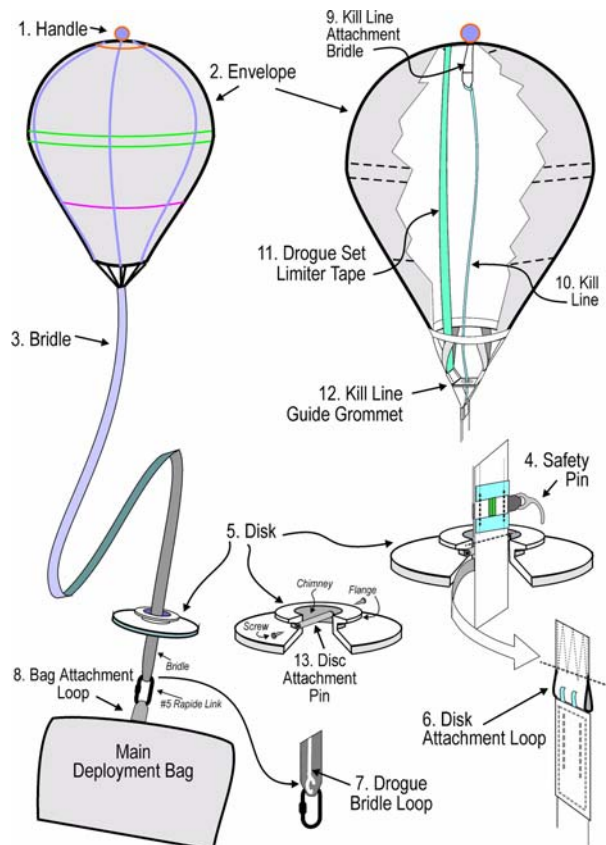

**Figure 3**

## THE SIGMA TANDEM SYSTEM

1. Check the envelope for tears and snags. Tiny holes can be ignored for a few jumps, but medium to large size tears must be repaired before the next jump.
2. Check the outer Kevlar bridle for signs of wear or broken stitches.
3. Check the inner Vectran/Spectra kill line for signs of wear. Common wear points are the upper and lower 30 inches of the bridle. The mid-section tends to outlast the ends. Although a kill line can last 100's of jumps, sandy or salty conditions can lower its life. Make sure **both** the kill line and the outer Kevlar bridle are attached to the bag loop with a correctly tightened #5 stainless rapid link. Because both the kill line and the bridle are attached at the same place, you no longer have to untwist the kill line before setting the drogue.
4. Check the disk for nicks, which can be caused by improper ground handling. **A deep, sharp nick could damage either the container or canopy** on the next jump, and should be sanded or buffed out. (Your main container top flap has Velcro pouches with spare parts, including Emory cloth and a 3/32" Allen wrench.)
5. Check that the disk attachment pin is threaded through its loop on the drogue bridle, and that the screws are tight. Tighten with a 3/32" Allen wrench if necessary. A loose screw could damage or snag the closing loop. A missing screw could cause the pin to slip out of the disk chimney, which would cause premature collapse of the drogue. **A little dab of Loc-Tite on the screws will help keep them in place.**

### Inspect and pack the canopy

The Sigma Tandem System accepts several different tandem canopies. Inspect and pack the canopy you are using in the normal manner. **(Fig. #4)**



**Figure 4**

## THE SIGMA TANDEM SYSTEM

### Close the main container

1. Insert the **Spectra** pull-up cord through the closing loop.

#### **WARNING:**

**Do not use anything but Spectra as a pull-up cord, or you will damage the closing loop.**

2. Place the bag into the container, retrieve the inner top flap, and tuck the lines well down into the bottom of the pack tray. **(Fig. #5)**

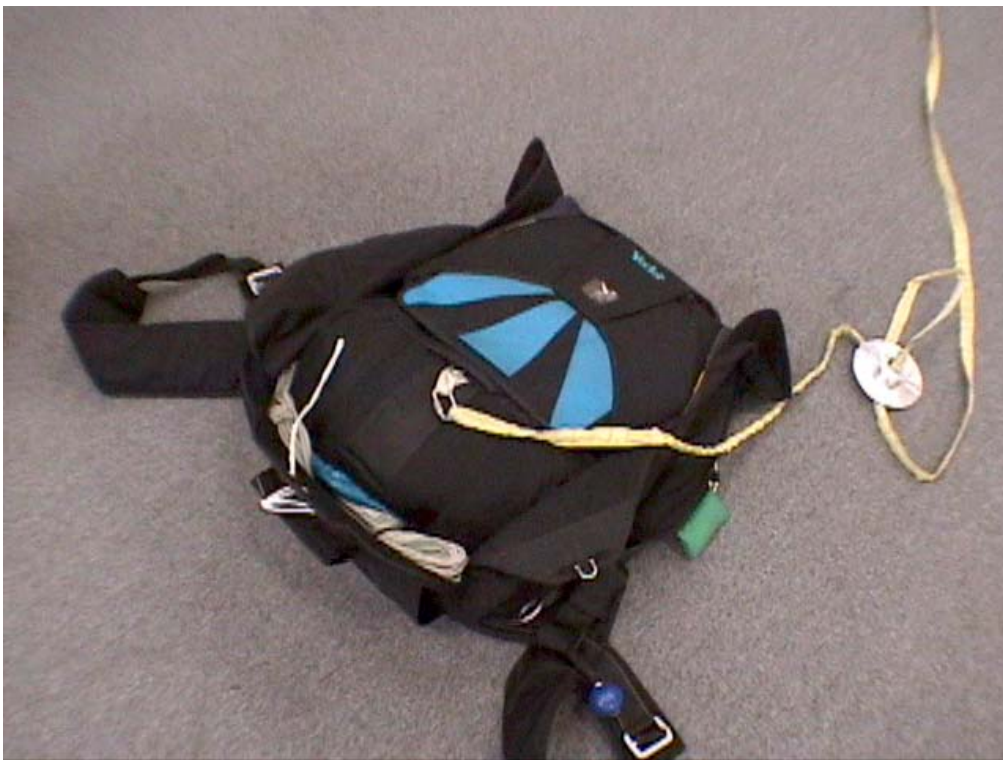

**Figure 5**

3. Kneel on the bag and pull upward on the inside top and side flaps to seat the bag in the pack tray.
4. **Set the drogue.** The drogue is collapsed after each use, and must be set (cocked) before closing the container. **There are several ways**

## THE SIGMA TANDEM SYSTEM

**to set the drogue.** Here is one. Secure the disk to the container by feeding the container- closing loop through the chimney in the center of the disk, and then back through the grommet on the main bottom flap, pinning it in place. **(Fig. #6)**



**Figure 6**

Stretch out the drogue bridle over the reserve container, so that you are pulling the main bottom flap, with the disk temporarily attached, inward over the bag. Remove any twists in the bridle as you go. **(Fig. #7)**

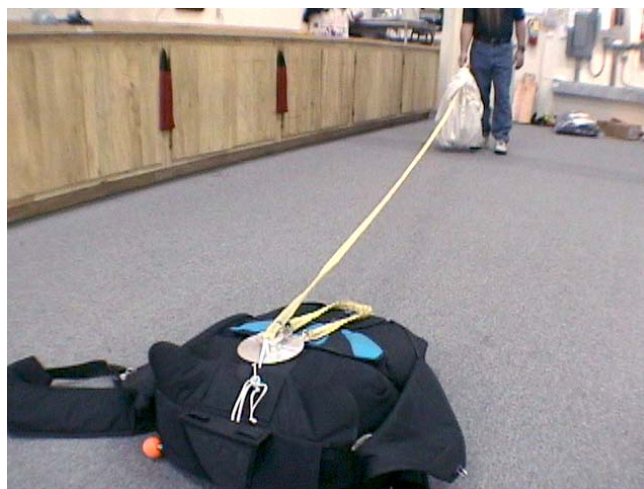

**Figure 7**

## THE SIGMA TANDEM SYSTEM

With the bridle held tight with one hand, pull the drogue apex handle as far as you can with the other. Because of an internal “set limiter” tapes, you will not be able to “stretch out” the drogue envelope as much as on earlier Vector drogues. Less set means less motion is necessary to collapse the drogue, and less friction will be generated. This means less wear and longer life on the kill line. The outer Kevlar bridle between the disk and the bag will scrunch up as you pull. **(Fig. #8)**

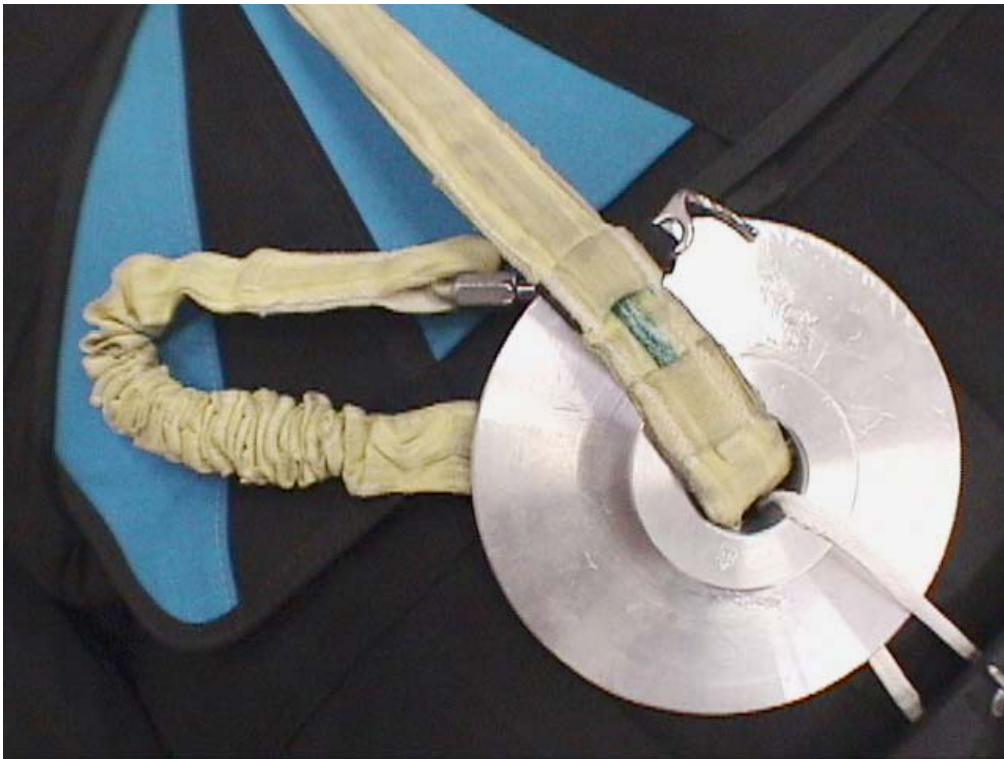

**Figure 8**

## THE SIGMA TANDEM SYSTEM

There is a “check window” in the bridle just above the disk. When the drogue is set, the colored section of the Vectran/Spectra kill line will be visible in this window. **(Fig. #9)**



**Figure 9**

It is also possible to set the drogue after you have closed the main container. Simply leave the left side of the center flap un-tucked and the “un-scrunched” bridle hanging out under it. Then extend the drogue bridle, and pull on the handle until the set limiter tapes are tight (and the colored section of the kill line shows in the check window). Now place the scrunched up bridle in the normal position, and tuck in the center flap. The main concern with this method is that you get into the habit of closing the container without first setting the drogue. If you don’t leave the “un-scrunched” bridle hanging out as a reminder, you might forget to set the drogue altogether. While our tests show that the drogue will probably set itself in this case, don’t depend on this feature.

## THE SIGMA TANDEM SYSTEM

Disconnect the disk from the bottom flap, and place it on top of the center of the bag, arrow pointing upward toward the reserve container. Place the “scrunched up” section of the drogue bridle up into the space between the main and reserve containers, off to the left side of the inside top flap. **(Fig. #10)**



**Figure 10**

### **WARNING**

**If the section of Kevlar drogue bridle between the disk and the bag is not “scrunched up”, the drogue has not been set, and may not open correctly when deployed. Set it now.**

5. Thread the pull-up cord through the end tabs on the right side flap (#1), the top flap (#2), and the left side flap (#3), in numerical order, and then up through the grommet on the bottom flap, ***counterclockwise***, in a circular fashion, surrounding the disc. **(Fig.# 11, 12)** The closing loop will cross itself, under the bottom flap grommets.

## THE SIGMA TANDEM SYSTEM



Figure 11



Figure 12

### **WARNING**

**Do not pass the closing loop over the drogue bridle above the disk. Doing so might cause damage to the rig or closing loop, as well as an inflated drogue-in-tow malfunction.**



## THE SIGMA TANDEM SYSTEM

6. Tie an overhand "slip knot" in the pull-up cord as close to the bottom flap grommet as possible. Insert either a short "handle" (**Fig. #13**)

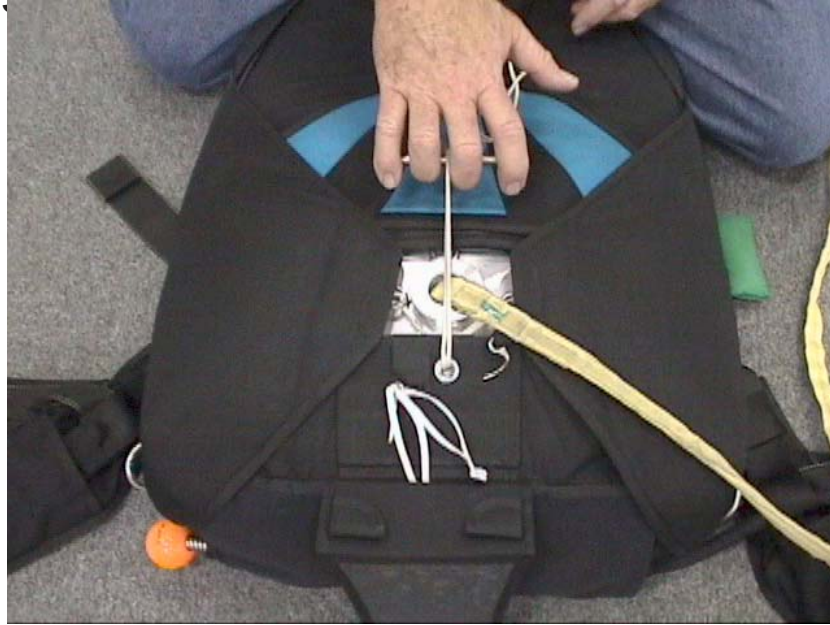

**Figure 13**

- or a 6" section of folded back drogue bridle to form a handle, (**Fig. #14**)

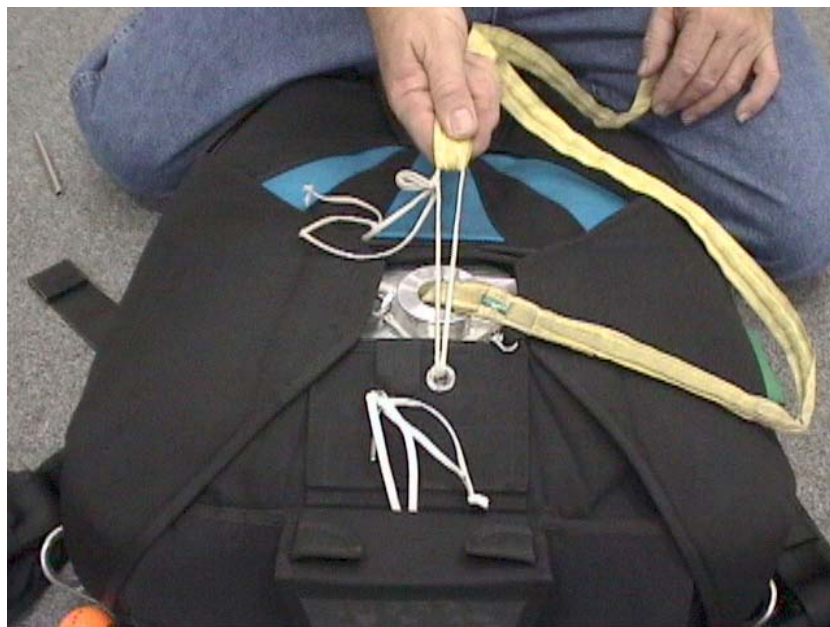

**Figure 14**

## THE SIGMA TANDEM SYSTEM

through the loop below the knot. You will need this handle for two reasons. First, Spectra is slippery, skinny, and generally hard to hold on to. Secondly, you have to snug up all four flaps at once on this design, instead of one-at-a-time as on other rigs. This will take more force than usual, and the handle allows you to comfortably do this.

7. **Kneel at the TOP (reserve end) of the rig** and pull the flaps **OVER** the edges of the disk, (**Fig. #15**) and snugly around the chimney in the center of the disk, **UNDER** the flange. "Patting" the flaps inward as you pull will help the process. **Pull at a low angle over the reserve container**, not upward away from the rig. If you find this process difficult, it is because you have not filled the bag correctly, have not placed the bag fully down into the pack tray before attempting to close the flaps around the disk, you are not kneeling at the reserve end of the container while pulling, or you have not threaded the closing loop correctly.



**Figure 15**

## THE SIGMA TANDEM SYSTEM

8. Insert the closing pin through the closing loop all the way up to the eyelet. Slide the tip of the pin under the 1" Type 4 pin protector tape to the left side of the final grommet, **above the closing loop button**, and not under the flange, exactly as shown in **Fig. #16**.



**Figure 16**

9. Remove the pull-up cord.

## THE SIGMA TANDEM SYSTEM

### Three Cautions:

- a. Rotating the tip of the pin back toward the bottom of the rig, and sliding it **UNDER** (below) the closing loop button will result in a hard or impossible pull. (Fig. #17a)
- b. The friction of the tip of the pin on the underside of the flange might cause a harder pull.
- c. Be sure you have not twisted the two Spectra ripcords around each other, as several twists will increase your pull force by removing the “pulley” effect. (Fig. #17b) The pulley effect works best if the Spectra ripcords exit the pin eyelet from the top, on their way to the housings, as shown in Fig. #16.

**WARNING: DO NOT CLOSE CONTAINER AS SHOWN IN FIGURES 17a & 17b.**



Figure 17a



Figure 17b

**WARNING: DO NOT CLOSE CONTAINER AS SHOWN IN FIGURES 17a & 17b**

## THE SIGMA TANDEM SYSTEM

10. Lift the bridle vertically above the disk to insure that the closing loop does not pass over the bridle between the disk and the drogue envelope. Notice how the ripcords exit the ripcord pin eyelet. (**Fig. #18**)



**Figure 18**

11. Sometimes a new, stiff drogue bridle will slightly “uncock” itself while you are closing the container. If the colored section of the Vectran kill line is not visible in the outer Kevlar bridle’s “check window”, extend the drogue bridle, and pull on the drogue apex handle, to re-cock the drogue. Insert the curved “safety pin” on the drogue bridle, down through the eyelet in the ripcord pin, and then down through the grommet beneath it. (**Fig. #19**)



**Figure 19**

## THE SIGMA TANDEM SYSTEM

12. Tuck the drogue bridle under the right side flap all the way down to the Spandex drogue pouch. **(Fig. #20)**



**Figure 20**

13. Pull on both ripcord handles, one at a time, to check their function, the function of the safety pin, and to pull the slack in the system down into the housings where it is out of the way. Applying a little finger pressure at the point where the ripcords go under the drogue pouch, while pulling and slowly releasing the handles, will keep the slack in the housings. **(Fig. #22 & 23).**



**Figure 22**



**Figure 23**

## THE SIGMA TANDEM SYSTEM

14. Tuck under the two lower side tabs. (Fig. #24 & 25)



Figure 24



Figure 25

### **WARNING**

**Be careful not to tuck the side tabs around the ripcords or drogue bridle. Before tucking, make sure the ripcords are centered beneath the pin with all slack down in the housings, and that the drogue bridle are tucked well under the right side flap.**

## THE SIGMA TANDEM SYSTEM

15. Tuck in the cover flap. Dress and pull down the center flap, if necessary, so that the cover flap tucks into it as far as possible. **(Fig. #26)**



**Figure 26**

16. Flake and insert the drogue into its Spandex pouch. **(Fig. #27 - 30)**



**Figure 27**



## THE SIGMA TANDEM SYSTEM



**Figure 28**



**Figure 29**

## THE SIGMA TANDEM SYSTEM



**Figure 30**

17. Turn the rig over and “walk” on the main container to push the disk down into the bag yielding a flatter, more snag resistant main cover flap, as well as a better looking rig. **(Fig. #31)**



**Figure 31**

## THE SIGMA TANDEM SYSTEM

### **Sigma Tandem “Pin Check”**

#### **Back of Rig - Top Down**

1. Look through window in the yoke and check the Cypres.
2. Check that the yellow breakaway cable is threaded through the Collin's Lanyard loop inside the yoke.
3. Look through the reserve cover flap window and check the reserve pin seating, RSL connection, and loop condition.
4. Open the main cover flap and check the: A. Routing of the closing loop, B. Routing of the drogue bridle out of the top of the disk, C. Colored kill line in the drogue bridle set window, D. Locking pin and safety pin seating, and E. Ripcord routing toward the housings.
5. Check the drogue bridle routing to the pouch.
6. Check that the drogue is well placed in the pouch.
7. Check that both drogue release handles are in place.
8. Check the general condition of container.

#### **Front of Rig – Top Down**

1. Check that the riser covers correctly closed.
2. Check that the three ring release assembled correctly.
3. Check that the RSL is hooked up to right riser and routed correctly.
4. Check that the breakaway handle in place.
5. Check that the reserve ripcord is in its pocket, with slack in the cable.
6. Check the general condition of the harness webbing and hardware.

## THE SIGMA TANDEM SYSTEM

### Installing A New Sigma Drogue Kill Line

The Sigma drogue kill line is little more than a length of line with a finger locked loop at each end. But because each new drogue envelope and bridle may vary slightly, and each can stretch a bit after use, we cannot supply a finished replacement kill line that is the right length for all used drogues. Your replacement kill line has a finished loop at the envelope end, but you must finish the other end to match the particular drogue it is installed in.

**Before taking anything apart, and assuming you are replacing your kill line before it breaks, make the following observation so that you will understand what you are trying to accomplish.**

1. Attach the #5 rapid link (where the drogue attaches to the main deployment bag) to something that won't move.
2. Go to the other end of the drogue and locate the #0 guide grommet at the base of the envelope.
3. Place two fingers under, and on either side of the guide grommet, and grab the drogue apex handle with the other hand.
4. Apply equal tension (at least 10 pounds) against the drogue bridle and kill line, with each hand.
5. Notice that the lark's head knot, where the kill line attaches to the kill line attachment bridle, is about 1½ " above the guide grommet.

**If the kill line were more than 1" shorter, the knot would strike the grommet each time the drogue collapsed, causing excessive wear on both. If the kill line were more than 2" longer, the drogue would not properly collapse during deployment, causing hard openings and canopy damage. Now, find a friend, follow the instructions below, and achieve the same result with your new kill line.**

1. Remove drogue kill line from Rapid link at the bag end.
2. Tie a piece of hand tack cord to old kill line.
3. Re-close the rapid link and secure it to something that won't move.
4. Go to envelope end of drogue and pull the tacking cord through the Kevlar drogue bridle using old kill line.
5. Un-knot old kill line from drogue apex, and discard.
6. Larks-head (knot) the new kill line to the drogue apex.

## THE SIGMA TANDEM SYSTEM

7. Tie the hand tack cord to the unfinished end of the new kill line, and while you hold the bridle tight, have your friend pull it back down through the drogue bridle.
8. Place two fingers of one hand below and on either side of the guide grommet at the drogue envelope base and pull the bridle tight (at least 10 pounds of pressure), while loosely holding the drogue apex handle with the other hand.
9. Have your friend wrap the kill line around the #5 link and pull the kill line until the larks head knot at the drogue apex attachment is 1½ " above the guide grommet.
10. Pull equal tension on both the Kevlar outer bridle and the kill line, and have your friend mark the new kill line where it passes around the inside of the link.
11. Relax all tension and make a mark 1" above (toward the drogue envelope) the first mark, and again 3" inches above the second mark.
12. Attach a finger lock tool to the loose end of the new kill line. Insert it at the second mark, and push it out at the third mark, so that the mark your friend made is at the bottom of a 1" loop, and you have a finger-locked area about 3" long. Remove the finger lock tool, but don't cut or sew anything yet.
13. Loosen the rapid link, slip the 1" loop onto it, re-close the link, and again attach it to something solid.
14. Go to the other end of the drogue and repeat step #9, putting equal pressure on both the guide grommet and the apex handle. The larks head attachment knot should be 1" (plus or minus 1/4") above the guide grommet.
15. If this is true, bark-tack, zigzag over twice, or straight stitch over 4 times, the new finger lock, trimming off and retracting the loose end into the kill line. After the first use, the lark's head knot will tighten, yielding the correct 1½ " spacing.

**If you do not have a sewing machine, you can tie an overhand knot in the lower 3" finger-locked area, instead of sewing. But, because the knot will shorten the kill line by 2", you will have to make the kill line 2" longer in the first place. Test your new kill line for correct length before you cut off and tuck in the excess line. While this procedure works, sewing is preferred.**

## THE SIGMA TANDEM SYSTEM

### Replacing the Drogue Ripcord System

1. Pull one ripcord ball handle out a few inches and use a straight pin or hemostat, where the cord leaves the housing, to remove the recoil tension, making the larks head knot easier to untie.
2. Remove the ripcord ball handle, and tie a 36" length of hand tack cord to the loop. Remove the straight pin or hemostat, and pull the ripcord up out of the housing.
3. Untie the hand tack cord from the ripcord, and tie the two ends of the hand tack cord loosely together, so that you don't accidentally introduce a twist in the ripcords during reassembly.
4. Pull out the other handle, remove it from its ripcord, and tie another 36" cord to its loop.
5. Pull the other ripcord up through its housing, and tie both ends of the hand tack cord loosely together.
6. Un-loop the middle of the ripcord system from the container attachment loop, sliding the ripcord pin off over the loop.
7. Thread the new ripcord through the pin, and reverse the process. The short section of the ripcord goes to the left, through the short housing. There should be about the SAME amount of slack in BOTH ripcords (about 3") if you've done it right. If not, start over, and this time put the right (longer) ripcord, in the right housing, and the left (shorter) ripcord, in the left housing.
8. If you loose either of the 36" pull-through cords, you will probably have to use a gun cleaning rod to re-thread the ripcord.

# THE SIGMA TANDEM SYSTEM

## Test For Sigma Tandem Endorsement

1. Historically, what is the leading single cause of tandem fatalities?
2. How does the Sigma tandem system address this problem?
3. What differences in emergency procedures are there between the Vector II and Sigma tandem rigs?
4. Why must the main closing loop (and ripcord) on a Sigma tandem system be constructed of Spectra (microline)?
5. What is the only correct length for that closing loop?
6. Why must the pull-up cord used to close a Sigma tandem main also be Spectra?
7. Which side flap does the closing loop go through first when closing the container?
8. What might happen if you trap the drogue bridle, above the disk, under the closing loop?
9. What will happen to the pull force if you pack twists into the ripcords below the pin?
10. What will sticking the ripcord pin under the disk flange do to pull force?
11. What might happen if you use a disk with a sharp nick in it?
12. How could such a nick be caused, and how should it be removed?
13. What problems might a loose or missing disk pin attachment screw cause?
14. What is the purpose of the "safety pin" on the drogue bridle?
15. What would happen if the kill line were not attached to the #5 link at the top of the main deployment bag, or the kill line were to break during deployment?
16. What are the negative consequences of such an occurrence?
17. What did you forget to do, if the drogue bridle between the disk and the bag is not scrunched up prior to closing the container?
18. What is the purpose of the drogue set limiter tapes?
19. When collapsed, what is the correct distance between the bottom of the kill line attachment bridle, and the kill line guide grommet?
20. What problem does a kill line that is too short cause?
21. What problem does a kill line that is too long cause?

the uninsured

**RELATIVE**  
**WORKSHOP, inc.**



1645 Lexington Avenue ♦ DeLand FL 32724-2106 USA ♦ [www.relativeworkshop.com](http://www.relativeworkshop.com)  
Telephone +1 386 736 7589 ♦ Fax +1 386 734 7537 ♦ [rws@relativeworkshop.com](mailto:rws@relativeworkshop.com)



# Sigma / Vector Student Harness

## Addendum

February 2002



# THE SIGMA / VECTOR TANDEM STUDENT HARNESS

## Introduction

The Sigma / Vector Student Harness is quite a departure from previous tandem student harnesses. It was designed, with the help of a cardiologist, to safely contain the human body without cutting off normal blood flow. Disrupted blood flow is why almost all students on older student harnesses were uncomfortable, and why many got sick or even passed out.

A hip-hugging horizontal back and belt strap combination allows the main lift webs to be positioned, and held, more toward the front of the upper body than on other designs. This prevents the “squeezing” of the upper body and the inside of the upper legs which can cut off blood flow. It also automatically lifts the legs up and forward after opening, putting them in a safer position for landing.

The Student Harness was designed to comfortably and safely fit a wide range of body sizes and types. To accomplish this, it has **twelve** points of adjustment. This wide range of adjustment means that it is possible to give a tandem student a truly comfortable experience on their tandem skydive. However, **the harness must still be adjusted securely to fit the student’s body to prevent them from falling out in extreme situations and unusual body positions.**

While fitting this harness on a tandem student is not difficult, it is different from other harnesses you may have used in the past. The most important point to consider is the security of the student. You must insure that all straps are comfortably snug against the student’s body.

Please use the following guide to keep your students safe and comfortable.

# THE SIGMA / VECTOR TANDEM STUDENT HARNESS

## Adjustment Guide

1. Loosen the harness before donning.
2. Rotate the harness on the student's shoulders so the Top Attachment Snaps will be easy to hook up.
3. Adjust the chest strap loosely.
4. Adjust the Belt Strap so the main lift webs are positioned as shown. The Horizontal Back and Belt Straps should be tightened firmly around the hips.
5. Adjust the Main Lift Webs and Diagonals so the harness's Hip Junctions are resting squarely on the student's hips.
6. Tighten the Leg Straps.
7. Slide the Chest Strap vertically into the correct position and tighten.

**Tip:** It's recommended to hook up and pre-hang your student so the harness conforms to the student's body. Release the student and check all adjustment points. You may find it necessary to tighten the harness a bit more.



# THE SIGMA / VECTOR TANDEM STUDENT HARNESS

## Adjustment Guide



# THE SIGMA / VECTOR TANDEM STUDENT HARNESS

## Adjustment Guide

The Horizontal Back Strap must be positioned low and securely tightened. This is what keeps the student from falling backwards out of the harness on a hard opening.



# THE SIGMA / VECTOR TANDEM STUDENT HARNESS

## Adjustment Guide

On anyone with a larger body frame the Main Lift Webs should be positioned further apart than on a smaller person.

There is no single right way to fit every size or shape of the human body. The harness has 12 points of adjustment. Use them to totally surround and contain the student's body.

Notice how the main lift web is positioned more toward the side of the body than it would be on a smaller person.

From this position, six straps, going in every direction, totally contain the pelvic area. This containment appears appropriate on this person when the Main Lift Webs are further apart.

